

Panel mounted socket - Part no. 1395

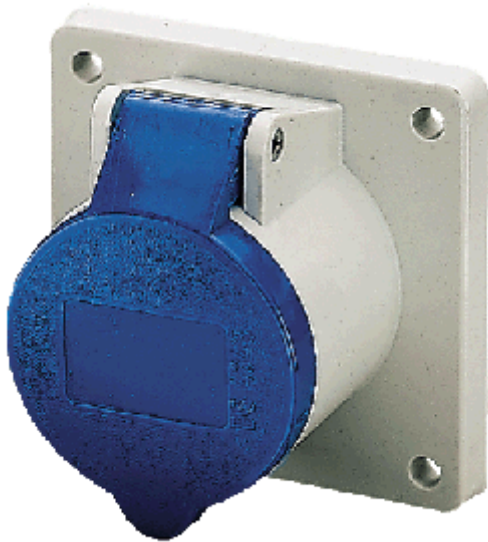

- screw terminals
- straight

Protection type	IP 44
Ampere	32 A
Poles	3 p
Voltage	230 V
Hertz	50-60 Hz
Earth position	6 h
Contact	standard
Connection technology	Screw terminals

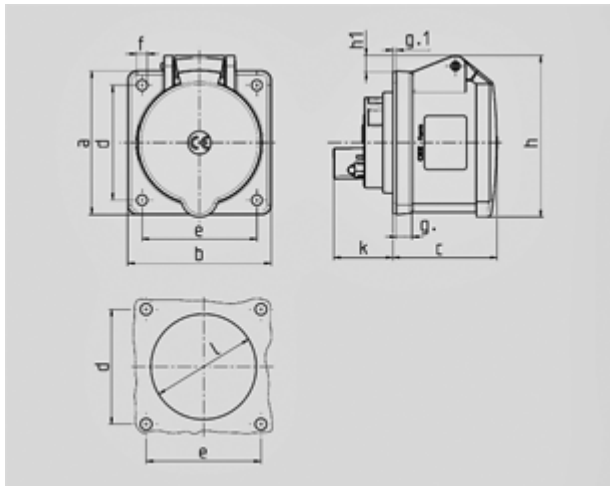

Drawing	Amp.	16			32		
		3	4	5	3	4	5
1 MB 247	Poles						
Dim. in mm	a	75	75	75	75	75	75
	b	75	75	75	75	75	75
	c	53	53	55	64	64	65
	d	60	60	60	60	60	60
	e	60	60	60	60	60	60
	f	5.5	5.5	5.5	5.5	5.5	5.5
	g.	8	8	8	8	8	8
	g.1	2	2	2	2	2	2
	h	75	80	83	89	89	100
	h1		6	8	11	11	12
	k	31	32	32	39	39	39
	l	43	52	54	58	58	62
	Terminal for cond. cross section (mm²) min.-max.	1.5	1.5	1.5	2.5	2.5	2.5
		-4	-4	-4	-10	-10	-10