

PHILIPS

Xitanium

LED driver



Datasheet

Xitanium LED drivers – Spot- and downlight

Xitanium 21W 0.5A 42V I 230V

Affordable and reliable LED Drivers

Affordable LED Driver range offering Philips reliability. The Xitanium range is compatible with COB and mid-power LEDs from any LED manufacturer.

Benefits

- Driver design based on Philips experience and knowledge of conventional fluorescent and HID technologies
- Various power wattage Drivers that are related to the lumen packages/applications
- Fixed output Drivers
- Independent-version housing design for stand-alone installations

Features

- Small, compact dimensions
- Specific, optimized output current and voltage
- 50,000 hours lifetime
- Fast Time to Market
- Low ripple, low THD

Application

- Public buildings (airports, cinemas, theaters, exhibition halls)
- Retail (supermarkets, shops)
- Office

Electrical input data

Specification item	Value	Unit	Condition
Nominal input voltage	220...240	V _{ac}	performance range
Nominal input frequency	50...60	Hz	
Nominal input current	0.12	A	@230V @ full load
Input voltage	230	V _{ac}	
Nominal input power	25	W	@230V @ full load
Power factor	>= 0.9		@ full load. See graph.
Total harmonic distortion	<= 15	%	@ full load. See graph.
Efficiency	84	%	@230V @ full load
Input voltage AC	202...254	V _{ac}	Operational range
Input frequency AC	47.5...63	Hz	Maximum permissible range

Electrical output data

Specification item	Value	Unit	Condition
Regulation method	Constant Current		
Output voltage	32...42	V _{dc}	
Output voltage max.	60	V	Peak voltage at open load
Output current	0.5	A	Full output current setting
Output current tolerance	± 8	%	
Output current ripple LF	<= 4	%	Ripple = peak / average
Output current ripple HF	<= 15	%	
Output power	16...21	W	Full output

Electrical data controls input

Specification item	Value	Unit	Condition
Control method	Fixed		

Logistical data

Specification item	Value
Product name	Xitanium 21W 0.5A 42V I 230V
Order code	
Logistic code 12NC	9290 014 10280
EAN3	
Pieces per box	48

Wiring & Connections

Specification item	Value	Unit	Condition
Input wire cross-section	0.2...1.5	mm ²	WAGO250 (3.5 mm), solid wire
	16...24	AWG	WAGO250 (3.5 mm), solid wire
Input wire strip length	8.5...9.5	mm	
Output wire cross-section	0.2...1.5	mm ²	WAGO250 (3.5 mm), solid wire
	16...24	AWG	WAGO250 (3.5 mm), solid wire
Output wire strip length	8.5...9.5	mm	
Maximum cable length	600	mm	Total length of wiring including LED module, one way

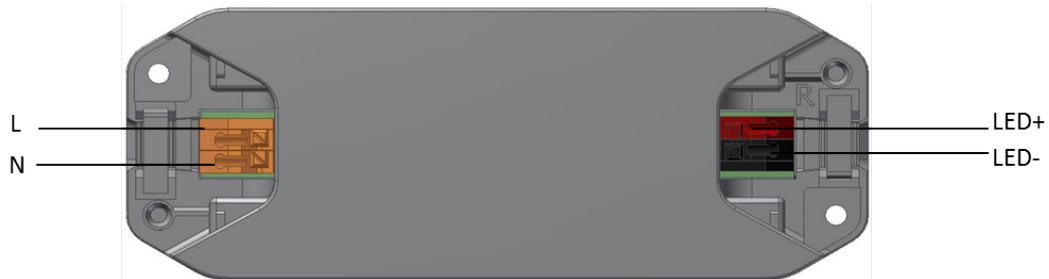

Insulation

Insulation	mains	output
mains		SELV
output	SELV	

Dimensions and weight

Specification item	Value	Unit	Condition
Length (A1)	115	mm	
Width (B1)	45	mm	
Height (C1)	29	mm	
Fixing hole diameter (D1)	3.4	mm	
Fixing hole distance (A2)	105	mm	
Weight	155	gram	

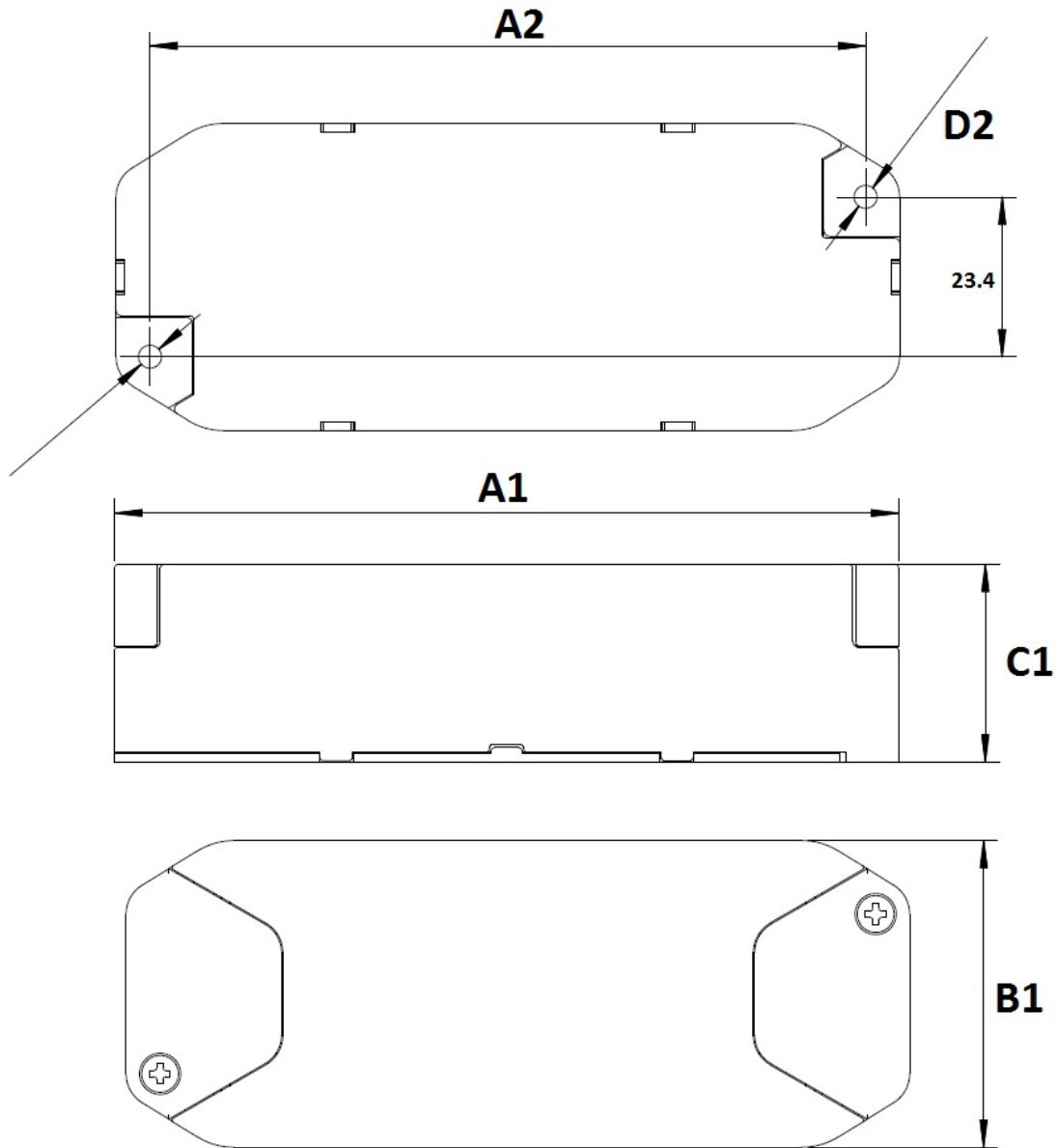

Operational temperatures and humidity

Specification item	Value	Unit	Condition
Ambient temperature	+0...+50	°C	
T _{case-max}	75	°C	Maximum temperature measured at T _c -point
T _{case-life}	65	°C	Measured at T _c -point
Maximum housing temperature	130	°C	In case of a failure
Relative humidity	10...90	%	Non-condensing

Storage temperature and humidity

Specification item	Value	Unit	Condition
Ambient temperature	-25...+85	°C	
Relative humidity	5...95	%	Non-condensing

Lifetime

Specification item	Value	Unit	Condition
Driver lifetime	50,000	hours	Measured temperature at T _c -point is T _{case} -life. Maximum failures = 10%

Programmable features

Specification item	Value	Remark	Condition
Set output current (AOC)	No	See Design-in guide.	Default output current: <= 500 mA
LED module temperature derating (MTP)	No		
Constant Lumen Over Lifetime (CLO)	No		
DC emergency dimming (DCemDIM)	No		
Corridor mode	No		
Energy metering	No		
Diagnostics	No		

Features

Specification item	Value	Remark	Condition
Open load protection	Yes		Automatic recovering
Short circuit protection	Yes		Automatic recovering
Over power protection	Yes		Automatic recovering
Hot wiring	No		
Suitable for fixtures with protection class	II		per IEC60598

Certificates and standards

Specification item	Value
Approval marks	CCC / CE / ENEC / RCM
Ingress Protection classification	20

Inrush current

Specification item	Value	Unit	Condition
Inrush current I_{peak}	11	A	Input voltage 230V
Inrush current T_{width}	200	μ s	Input voltage 230V, measured at 50% I_{peak}
Drivers / MCB 16A type B	≤ 55	pcs	

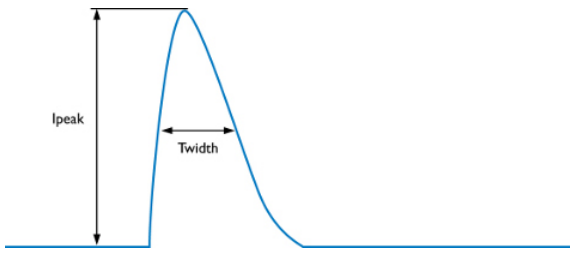

MCB	Rating	Relative number of LED drivers
B	10A	63%
B	13A	81%
B	16A	100% (stated in datasheet)
B	20A	125%
B	25A	156%
C	10A	104%
C	13A	135%
C	16A	170%
C	20A	208%
C	25A	260%

Driver touch current

Specification item	Value	Unit	Condition
Typical touch current	0.7	mA peak	Acc. IEC61347-1. LED module contribution not included

Surge immunity

Specification item	Value	Unit	Condition
Mains surge immunity (diff. mode)	1	kV	L-N, acc. IEC61000-4-5. 2 Ohm, 1.2/50us, 8/20us
Mains surge immunity (comm. mode)	2	kV	L/N - GND acc. IEC61000-4-5. 12 Ohm, 1.2/50us, 8/20us

Graphs

Operating window

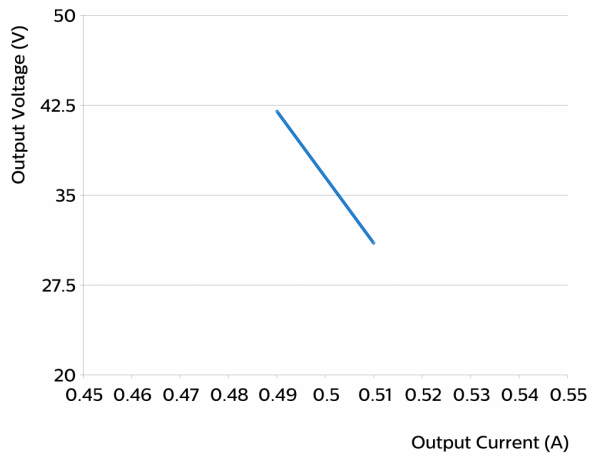

Power factor versus output power

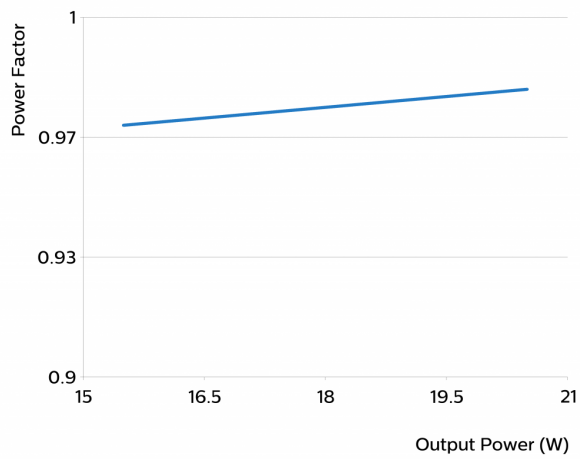

Efficiency versus output power

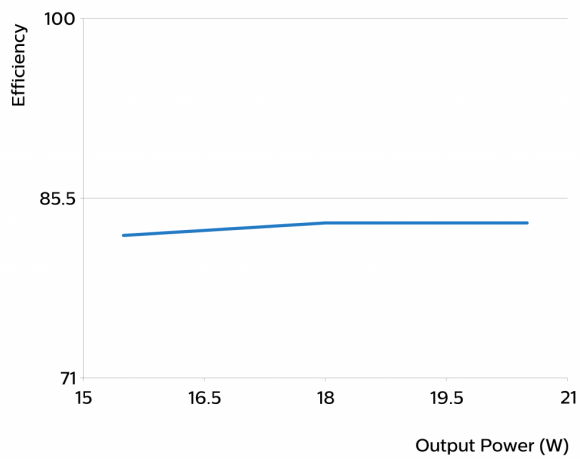

THD versus output power

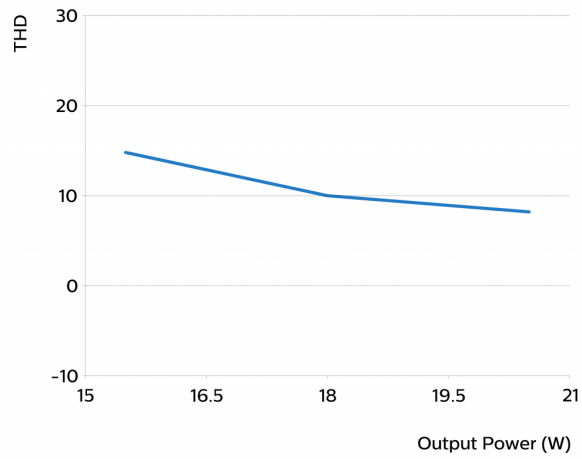

©2015 Koninklijke Philips Electronics N.V.

All rights reserved. Reproduction in whole or in part is prohibited without the prior written consent of the copyright owner. The information presented in this document does not form part of any quotation or contract, is believed to be accurate and reliable and may be changed without notice. No liability will be accepted by the publisher for any consequence of its use. Publication thereof does not convey nor imply any license under patent- or other industrial or intellectual property rights. Data subject to change.

Date of release: July 10, 2015

www.philips.com/technology