

HAKKO FU-601
SOLDERING STATION**Soldering iron unit****Instruction Manual**

Thank you for purchasing the HAKKO FU-601 soldering iron unit.
Please read this manual before operating the HAKKO FU-601.
Keep this manual readily accessible for reference.

**TABLE OF CONTENTS**

1. PACKING LIST	1
2. SPECIFICATIONS	1
3. WARNINGS, CAUTIONS AND NOTES	2
4. PART NAMES	3
5. INITIAL SETUP	5
6. OPERATION	8
7. PARAMETER SETTING	12
8. MAINTENANCE	15
9. CHECKING PROCEDURE	17
10. ERROR MESSAGES	18
11. TROUBLE SHOOTING GUIDE	19
12. DIMENSIONAL OUTLINE DRAWING	21
13. EXPLODED VIEW	22
14. PARTS LIST	22

1. PACKING LIST

Please check to make sure that all items listed below are included in the package.

HAKKO FU-601	1	Iron cable	1
HAKKO FU-6001 (HAKKO FU-6002)	1	Connecting cable	1
Flux protector	1	Power cord	1
Iron unit fixing assembly.....	1	Heat-resistant pad	1
Tip adjustment jig unit	1	Instruction manual	1
Feeder unit attachment screw	2		

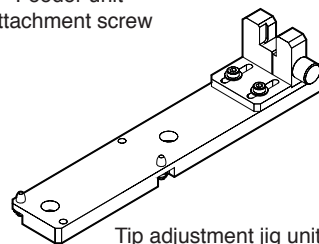
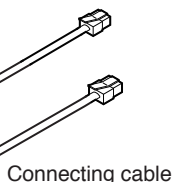
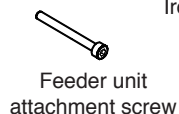
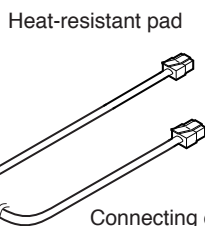
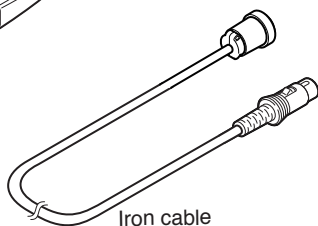
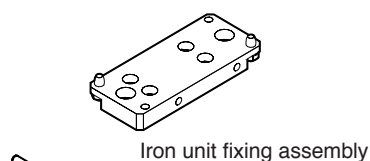
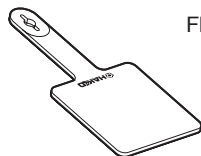
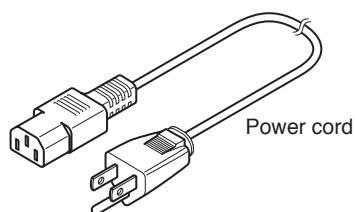
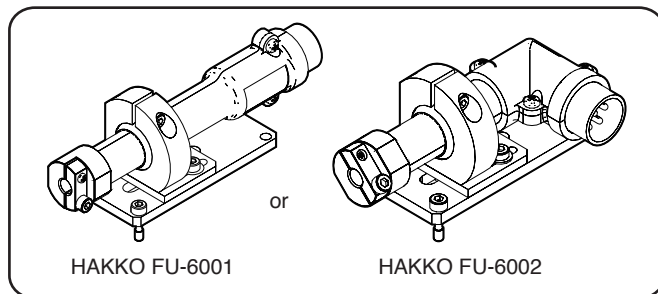
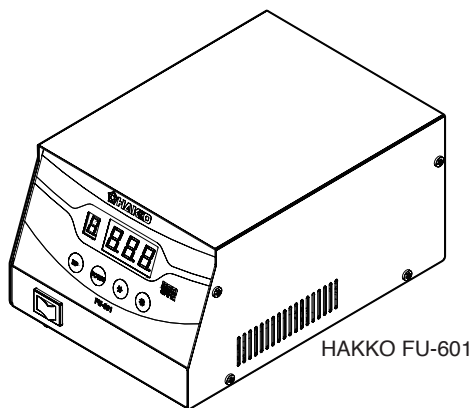

2. SPECIFICATIONS

*Tip is optionally available.
(See 14. Parts List in page 23.)

●HAKKO FU-601

Power consumption	300W
Temperature range	50 - 500°C (120 - 940°F)
Temperature stability	± 5 °C (±9°F) at idle temperature
Output Voltage	AC 29V
Dimensions (W × H × D)	145(W)×107(H)×211(D)mm (5.7 × 4.2 × 8.3 in.)
Weight	4 kg (8.8 lb.)

●HAKKO FU-6001/6002

Power consumption	260W (29V)
Tip to ground resistance	< 2 Ω
Tip to ground potential	< 2 mV
Cord length	3 m (9.8 ft.)
Total length *1	194 mm (7.6 in.)*2 {168 mm (6.6 in.)}*3
Weight *1	132 g (0.29 lb. / 4.66 oz.) {134 g (0.30 lb. / 4.73 oz.)}*3
	171 g (0.38 lb. / 6.03 oz.) {173 g (0.38 lb. / 6.10 oz.)}*3 (with iron unit fixing assembly)

- *The temperature was measured using the FG-101.
- *This product is protected against electrostatic discharge.
- *Specifications and design are subject to change without notice.

- *1 With 4XD tip
- *2 The dimension can be adjusted in range of ±5mm.
- *3 HAKKO FU-6002

■ Electrostatic Protection

This product includes such features as electrically conductive plastic parts and grounding of the unit as measures to protect the device to be soldered from the effects of static electricity. Be sure to observe the following instructions:

1. When making repairs or replacing parts, take sufficient care not to expose live electrical parts or damage insulation materials.
2. Be sure to ground the unit during use.

3. WARNINGS, CAUTIONS AND NOTES

Warnings and cautions are placed at critical points in this manual to direct the operator's attention to significant items. They are defined as follows:

 **WARNING** : Failure to comply with a WARNING may result in serious injury or death.

 **CAUTION** : Failure to comply with a CAUTION may result in injury to the operator, or damage to the items involved. Two examples are given below.

WARNING

When power is ON, tip temperatures will be between 50 and 500°C. (120 to 940°F)
To avoid injury or damage to personnel and items in the work area, observe the following:

- Do not touch the tip or the metal parts near the tip.
- Do not allow the tip to come close to, or touch, flammable materials.
- Inform others in the area that the unit is hot and should not be touched.
- Turn the power off when not in use, or left unattended.
- Turn the power off when changing parts or storing the HAKKO FU-601.
- This appliance is not intended for use by persons (including children) with reduced physical, sensory or mental capabilities, or lack of experience and knowledge, unless they have been given supervision or instruction concerning use of the appliance by a person responsible for their safety.
- Children should be supervised to ensure that they do not play with the appliance.
- The unit is for a counter or workbench use only.

●To prevent accidents or damage to the HAKKO FU-601, be sure to observe the following.

CAUTION

- Do not use the HAKKO FU-601 for applications other than soldering.
- Do not give an excessive shock to the iron.
- Remove power and iron cords by holding the plug. not the wires.
- Do not modify the HAKKO FU-601.
- Use only genuine Hakko replacement parts.
- Do not allow the HAKKO FU-601 to become wet, or use it with wet hands.
- Be sure the work area is well ventilated. Soldering produces smoke.
- Be sure the cooling fan at the rear of the station is unrestricted.
- While using the HAKKO FU-601, don't do anything which may cause bodily harm or physical damage.

4. PART NAMES

● HAKKO FU-601

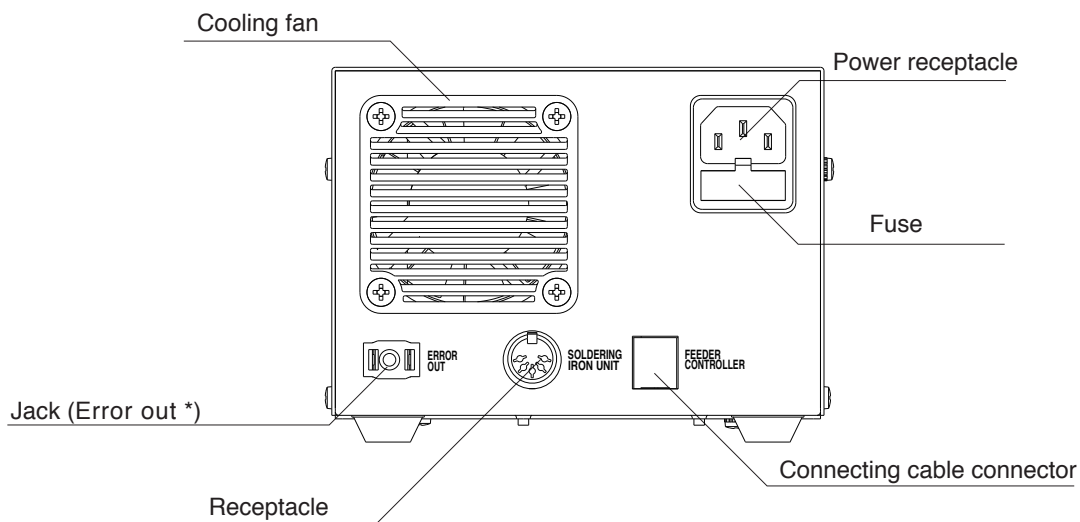
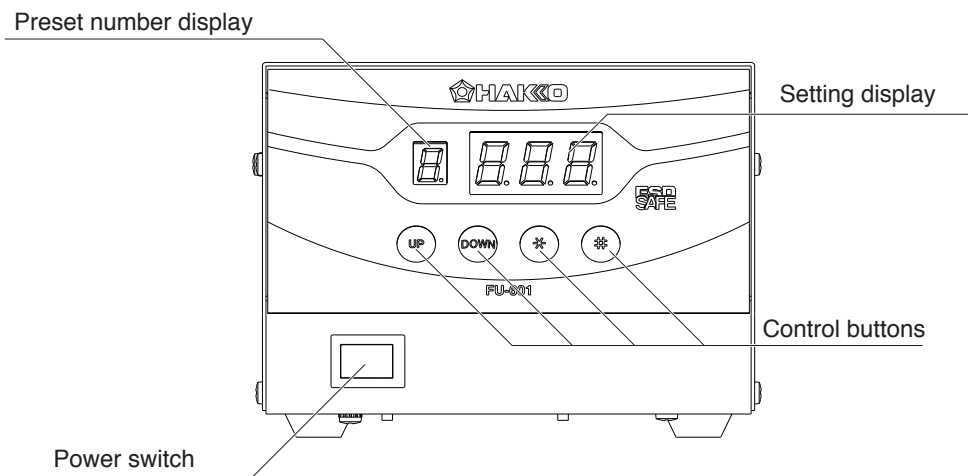

* Error out circuit

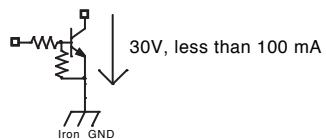

● HAKKO FU-6001

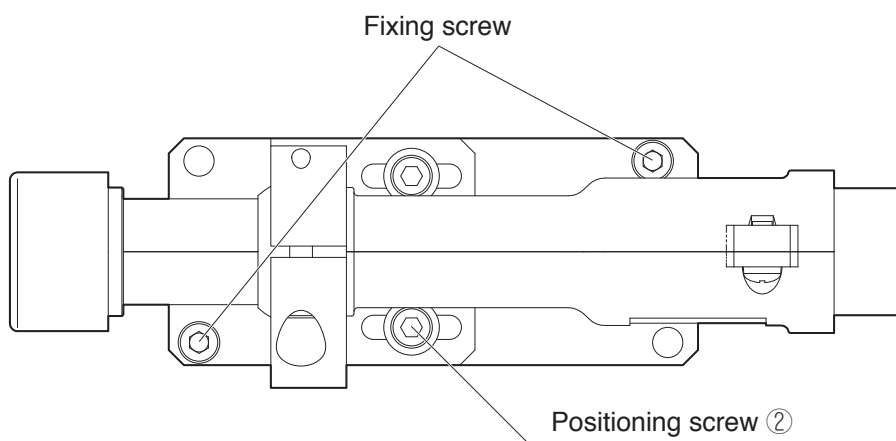
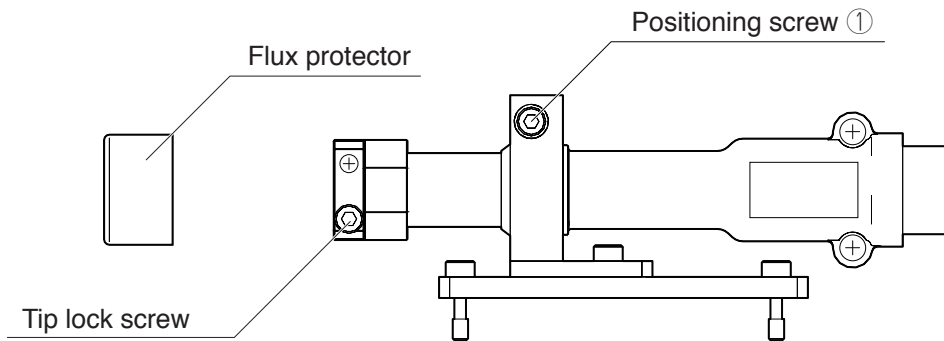

⚠ CAUTION

Do not touch any screws than the hexagon socket head cap screws described in this manual.

5. INITIAL SETUP

Use a hex wrench of 2.5 mm.

Connecting components

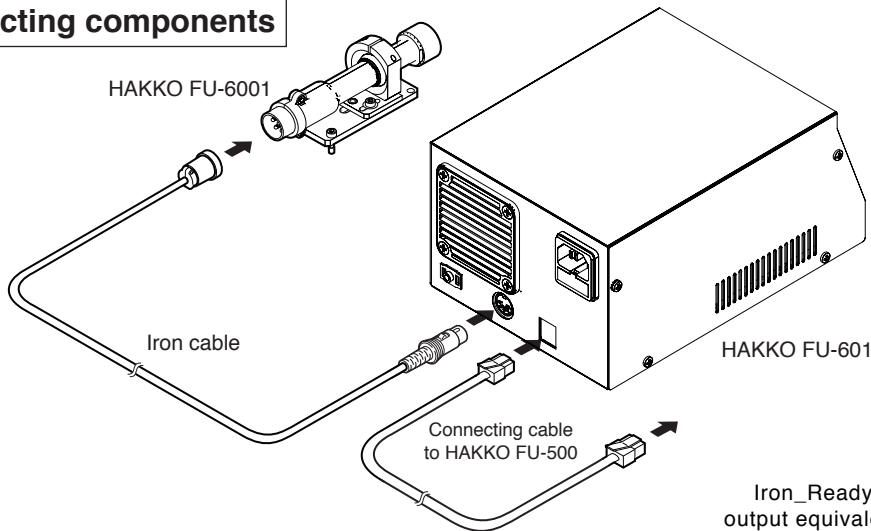

Connecting cable (6-pole 6-core modular cable)

Pin No.	Signal name	I/O	Function
1	TxD	Out	Outgoing data
2	RxD	In	Incoming data
3	Iron_Ready	Out	HAKKO FU-601 Ready signal
4	Iron_GND		HAKKO FU-601 GND
5	Iron_GND		
6	Iron_Vcc	Out	HAKKO FU-601 Vcc (5V)

Iron_Ready signal output equivalent circuit

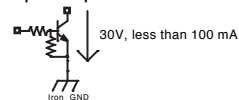

Recommended Iron_Ready signal connection diagram

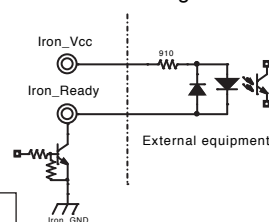

● How to attach the tip

⚠ CAUTION

Replace the iron tip when it is cold.
If you need to replace the hot iron tip, always use a heat-resistant pad.

1. Slide off the flux protector and loosen the tip lock screw.

※Do not touch this screw during iron tip replacement.

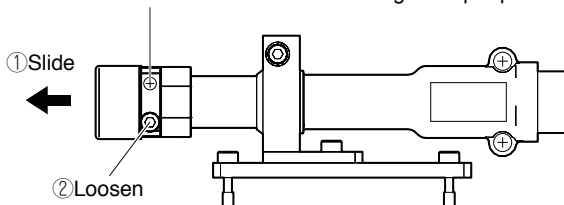

2. Insert a tip. Tighten the tip lock screw and reinstall the flux protector.

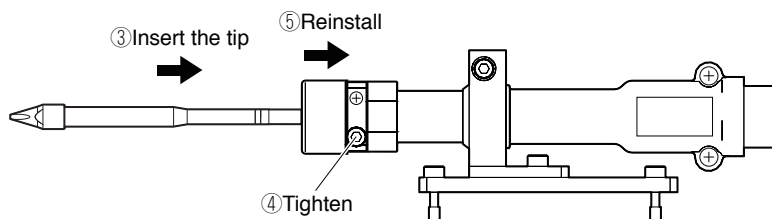

⚠ CAUTION

Make sure that there is no clearance between the tip and the hole of the flux protector.

● How to position the tip

- To turn the shaft of the tip, loosen the positioning screw ①.
To move the soldering iron in the longitudinal direction, loosen the positioning screw ②.
Tighten the screws after determining the tip position balancing with your work object.

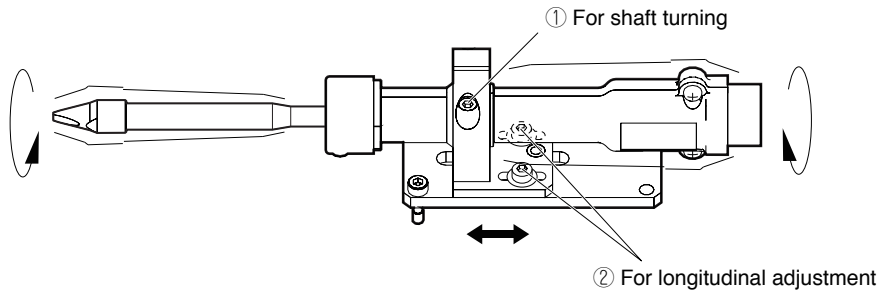

- Loosen the following screws ① and ② and place the HAKKO FU-6001 on the tip adjustment jig unit with the positioning pins aligned.

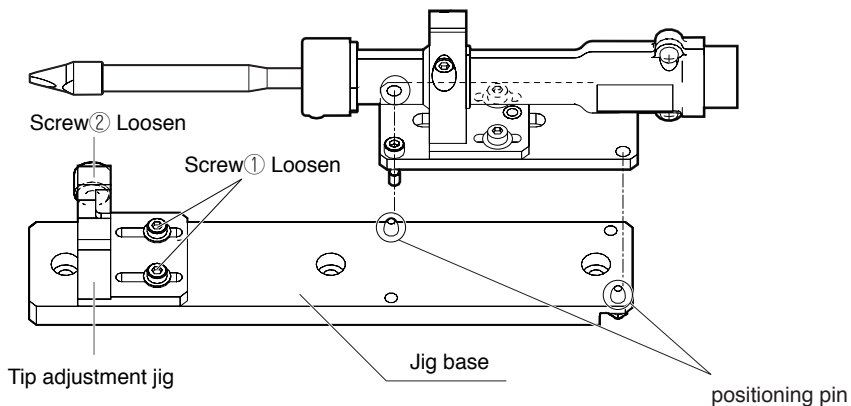

- Align the D-cut face of the tip with the pocket in the fixed side.
Move the tip adjustment jig until the tip is fully inserted as shown in the following figure.
This position will be the reference point. Retighten the two screws ①.

To prevent the upward movement and misalignment of the tip, tighten the screw ② while pressing the tip from the top.

Do not move the jig except for the one on the movable side and except for the time when the type of workpiece is changed. After the reference point has been set, remove the HAKKO FU-6001 from the tip adjustment jig unit.

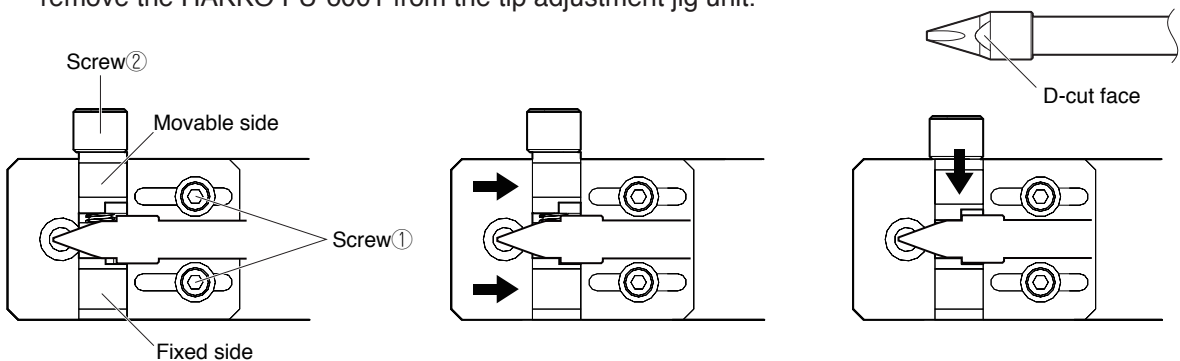

4. Place the HAKKO FU-6001 on the iron unit fixing assembly and tighten the two screws.

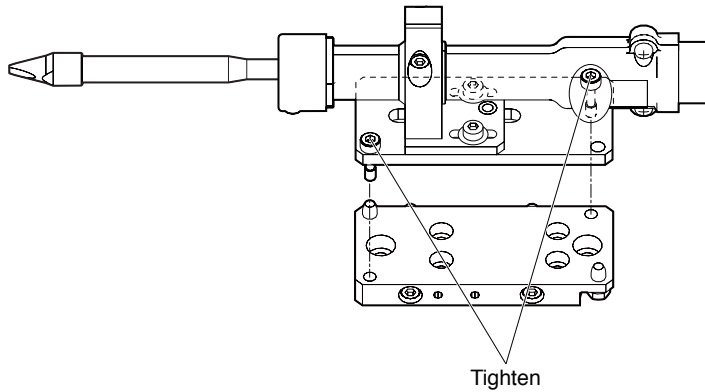

● Installing the iron to the feeder unit

Tighten the feeder unit set screws as shown in the figure below.
Now you can install the HAKKO FU-6001 to the feeder unit.

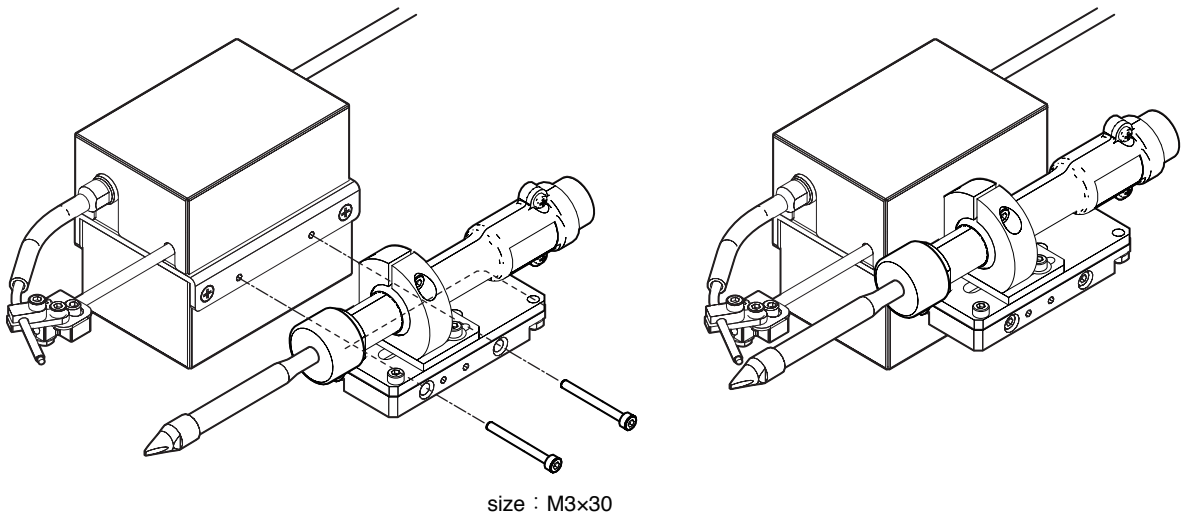

● How to position the tip after replacement

After replacement, you need to position the tip.
Loosen the positioning screw and align the tip with the reference point set in the previous page.

To prevent the upward movement and misalignment of the tip, tighten the screws while pressing the tip from the top.

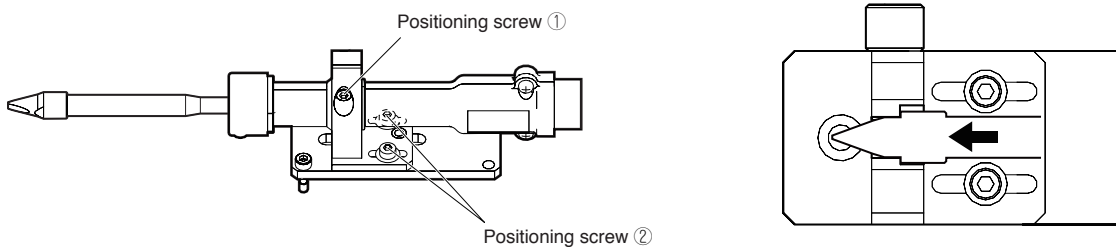

6. OPERATION

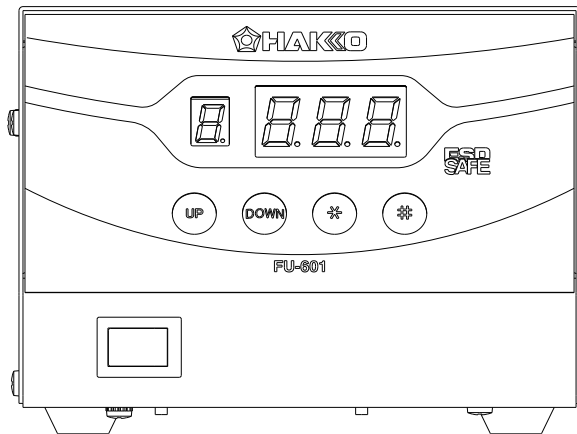

The HAKKO FU-601 has the following four control buttons.

- UP** — When press for less than one second, enters preset number selection screen. When press and hold for at least one second, enters preset temperature changing screen. Increase the value in the appropriate display window.
- DOWN** — Decrease the value on the display.
- *** — End of sequence signal (terminates a phase in a data entry mode) ; When press and hold for at least one second, enters set temperature mode. when press for less than one second, displays current set temperature.
- #** — When press and hold for at least one second, enters offset mode. When press for less than one second, displays current offset value.

⚠ CAUTION

An audible buzzer is provided to alert the operator.

- When the station has reached the set temperature, a buzzer will sound once.
- When the low temperature threshold has been crossed, a buzzer will sound continuously. This buzzer will shutoff when the sensed temperature returns to the acceptable range.
- When there is the possibility that a failure has occurred in the sensor or heater, a buzzer will sound continuously.

Operation

1. Turn on the power switch.
2. Once the temperature is reached, a buzzer sounds.

By default, the temperature is set to 350°C. (662°F)
Check the temperature setting by pressing the * button.
The set temperature will be displayed for two seconds.

Changing temperature setting

⚠ CAUTION

The temperature range is from 50 to 500°C. (120 to 940°F)

● If you enter a value outside the temperature setting range, the display returns to the hundreds digit, and you have to enter a correct value.

Example : 350 to 400°C

1. Press and hold the  button for at least one second.
The hundreds digit will begin to flash.

2. Entering from hundreds to units digit
Press the  or  to set the desired figure.

Only values from 0 to 5 can be selected when entering the hundreds digit.

(In °F mode, values from 1 to 9 can be selected.)

Values from 0 to 9 can be selected when entering the tens or units digits.

(The same values can be selected in °F mode.)

When desired figure is displayed, press the  button to enter.

The next digit will begin to flash. After entering the units digit, press the  button to save the figure to the system memory and begin heater control with new setting temperature.

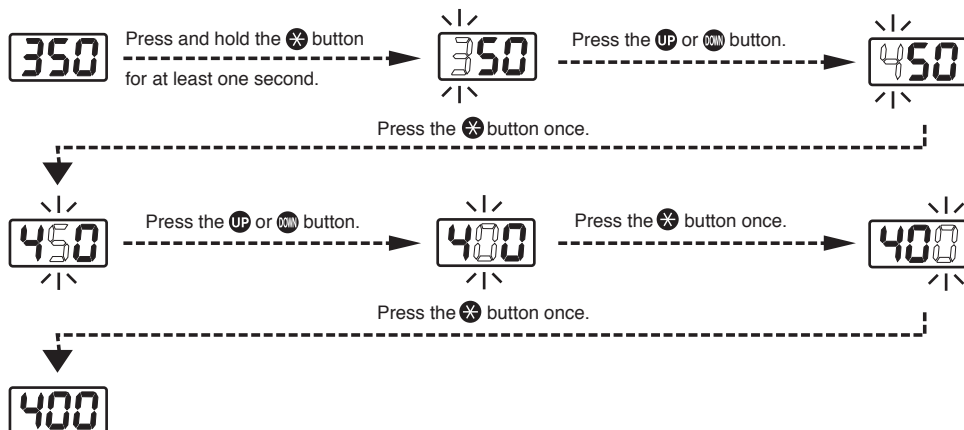

⚠ CAUTION

If power is switched off or lost during the execution of this procedure, no data will be entered. The entire procedure must be repeated from step 1.

Selecting the preset number

You can call up the preset temperature by pressing the buttons.

Initial preset temperature is 0 : 300°C, 1 : 350°C, 2 : 375°C, 3 : 400°C, 4 : 450°C and 5 : 500°C.

Example : preset number 0 (300°C) to No.3 (400°C)

1. Press the **UP** button once.
Preset number display will begin to flash.
2. Press the **UP** button three times to change the preset number display to **3**.
3. Press the **✖** to set the value.

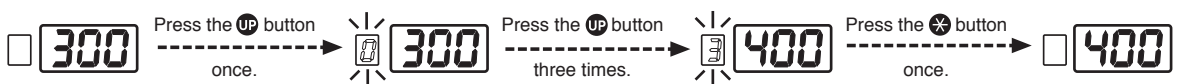

Changing the preset temperature

You can change the preset temperature. (0 to 5)

Example : 400 to 410°C at preset No.3

1. Press and hold the **UP** button for at least one second.
Both preset number display and setting display will begin to flash.
2. Press the **UP** button three times to change the preset number display to **3**.
3. Press the **✖** button to set the value.
4. Use the method for setting the temperature to enter and set the preset temperature.

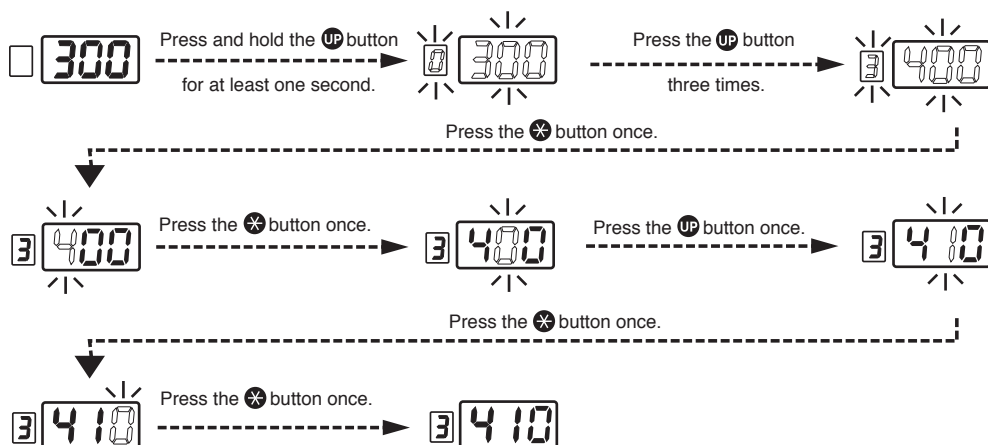

Entering the tip offset value

Example : If the measured temperature is 410°C and set temperature is 400°C, the difference is -10°C. (need to decrease by 10°C) So, enter the figure which 10 is deducted from present offset value.

1. Press and hold the **#** button for at least one second.
The hundreds digit will begin to flash, the unit will move to the offset mode.
2. Enter the offset value (-10) which is the difference between tip temperature and set temperature.

The allowable ranges for offset values are from -50 to +50°C (In °F mode, from -90 to +90°F)
If you enter a value outside the offset value range, the display returns to the hundreds digit, and you have to enter a correct value.

3. Entering from hundreds to units digit
Press the **UP** button or **DOWN** to set the desired figure.

The hundreds digit can display 0 (for positive value) or minus sign (for negative value)
(Same values vcan be selected in °F mode.)

Values from 0 to 5 can be selected when entering the ten digit.
(In °F mode, values from 0 to 9 can be selected.)

Values from 0 to 9 can be selected when entering the units digit.
(Same values can be selected in °F mode.)

After entering the units digit, press the **✖** button to save the figure to the sytem memory and begin heater control with the new offset value.

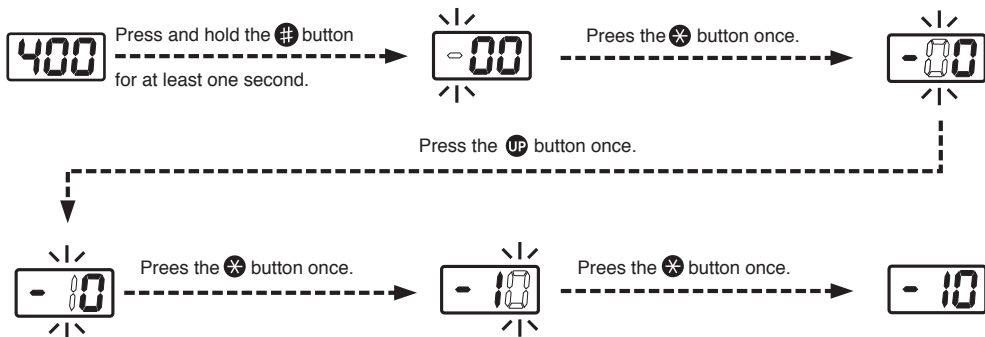

7. PARAMETER SETTING

Parameter name	Parameter number	Value	Initial value
Temperature display	01	°F (F) / °C (C)	°C
Low temperature error setting	03	30 - 300°C (54 - 540°F)	300°C
Buzzer setting (S-E sound , C-E sound)	05	OFF(0) / ON(1)	ON (1)
Buzzer setting (set temperature achieving alert)	06	OFF(0) / ON(1)	ON (1)
Power-mode setting	12	High power(0) / Normal power(1)	High power(0)
Password lock setting	14	Open(0) / Partial(1) / Restricted(2)	Open(0)
Changing the set temperature		[10] : ○* / [11] : ×*	[11]
Changing the preset number		[20] : ○* / [21] : ×*	[21]
Changing the offset value		[30] : ○* / [31] : ×*	[30]
Password		A B C D E F Select three letters	—
Ready signal delay time	20	0 - 60 sec.	3 sec.
Cable length setting	23	3, 5, 8 m	3 m
	24	[t1] (TX1) / [t2] (TX2)	[t2]

* ○ : Password not required × : Password required

Turn on the power switch while pressing the **⊗** and **⊕** button, the station will enter the parameter setting mode. (When the display shows 01 flashing, the station is in the parameter setting mode.)

Use the **UP** or **DOWN** button to select parameter number and press the **⊗** button to move to next step. Use the **UP** or **DOWN** button to select and press the **⊗** button to set the desired figure.

After the necessary parameters are set, press and hold the **⊗** button for at least one second.

The display changes to [Y] (Yes) and press the **⊗** button to exit the parameter entry mode.

If you press the **UP** or **DOWN** button to select [N] (No), you will return to previous screen.

⚠ CAUTION

If the power switched off or lost during the execution of this procedure, no data will be entered.

● 01 : Temperature display

When the display changes to [C] or [F], the station enters the mode for changing the temperature display.

[C] : °C (Celsius)

[F] : °F (Fahrenheit)

● 03 : Low temperature error

· When the temperature drops below a set limit, an error is displayed and a buzzer sounds.

When the temperature returns within the allowable range, a buzzer stops.

Low temperature setting range : For Celsius 30 - 300°C / For Fahrenheit 54 - 540°F

Example : When the set temperature is 350°C and low temperature error setting is 100°C, a buzzer sounds when the temperature drops to 250°C.

The hundreds digit begins to flash when entering the low temperature setting mode. Use the method for setting the temperature to enter and set the low temperature setting. If you enter a value outside the low temperature setting range, the display returns to the hundreds digit, and you have to enter a correct value.

● 05 : S-E, C-E buzzer sound setting

In the buzzer setting mode, which sets whether to sound the buzzer when a sensor error or soldering iron error occurs, either or is displayed.

: The buzzer does not sound when error occurs.

: The buzzer sounds when error occurs.

● 06 : Set temperature achieving alert setting

In the set temperature alert setting mode, either or is displayed.

: The buzzer does not sound when the soldering iron reaches the set temperature.

: The buzzer sounds when the soldering iron reaches the set temperature.

● 12 : Power-mode setting

NOTE: High-power mode is mainly suited to applications that require large heat capacity such as quick soldering of ground patterns or cast metal products.

In the Power-mode setting mode, either or is displayed.

: Selects high output.

: Selects normal output.

● 14 : Password lock setting

It is possible to restrict certain setting change to the unit.

- Moving to the parameter setting mode
- Changing the set temperature
- Changing the preset number
- Changing the offset value

There are three choices for the password lock setting.

※The move to parameter setting requires you to enter the password in either Partial or Restricted.

(Open) : You can make changes without entering a password.

(Partial) : You can choose whether or not password is needed to make changes.

	Password not required	Password required
Set temperature	<input type="text" value="1 0"/>	<input type="text" value="1 1"/>
Preset No.	<input type="text" value="2 0"/>	<input type="text" value="2 1"/>
Offset value	<input type="text" value="3 0"/>	<input type="text" value="3 1"/>

(Restricted) : A password is required to make any changes.

■ Password setting

If selecting the Restricted, perform the setting for password.

If selecting the Partial, choose whether or not the password function is needed when changing the set temperature, the preset number and the offset value and set the password.

Select and input three letters for password from six letters as follows.



The letters for password

Example : The procedure for changing the set temperature when the unit is restricted by a password. (password is AbC)

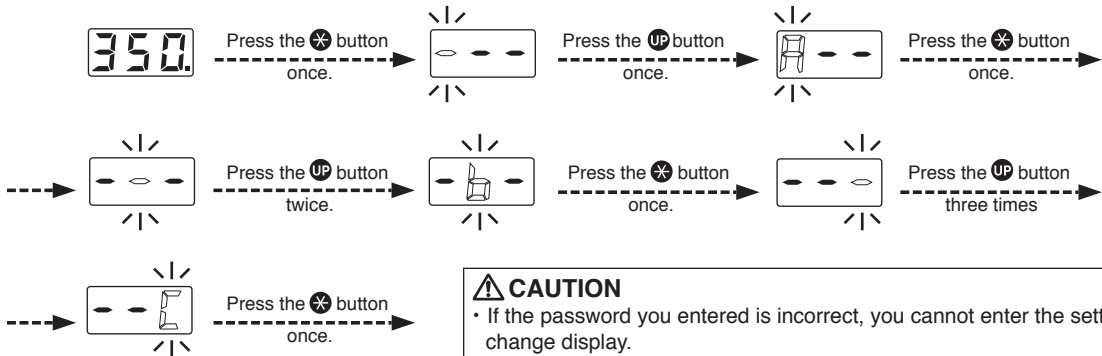

⚠ CAUTION

- If the password you entered is incorrect, you cannot enter the setting change display.
- If you enter the password incorrectly twice in a row, the display will return to the previous display.

● 20 : Ready signal delay time

You can set the delay time after the HAKKO FU-600 gets ready (ie., the temperature of the tip reaches the set value) until the Iron Ready signal becomes on.

Delay time setting range : 0 - 60 sec.

The tens digit begins to flash when coming to the delay time entering mode.

Use the method for setting the temperature to enter and set the delay time.

If you enter a value outside the delay time setting range, the display returns to the tens digit, and you have to enter a correct value.

● 23 : Cable length setting

By setting the iron cable length, you can adjust the output power.

⚠ CAUTION

Be sure to selected the length of the cable when you use a different lengths of the cable. Failure to do this may result in a tip temperature that is much higher or lower than the previous one.

Selection of cable length : 3m, 5m, 8m

Select the cable of the kind used.

● 24 : Tip setting

TX1 series of the tip (for the HAKKO FU-600) can be connected to the HAKKO FU-601.

⚠ CAUTION

Be sure to selected the tip of the kind used when you use a different kind of the tip.
Failure to do this may result in a tip temperature that is much higher or lower than the previous one.

Tip selection: TX1, TX2

Select the tip of the kind used.

8. MAINTENANCE

Performing proper and periodic maintenance extends product life and contributes to the quality of soldering work. Efficient soldering depends upon the temperature, the quality and quantity of the solder and flux. Apply the following service procedure as dictated by the conditions of the usage.

⚠ WARNING

Since the soldering iron can reach a very high temperature, please work carefully. Except where indicated, always turn the power switch OFF and disconnect the power plug before performing any maintenance procedure.

● **Tip maintenance**

1. Tip temperature

High temperatures shorten tip life and may cause thermal shock to components. Always use the lowest possible temperature when soldering. The excellent thermal recovery characteristics of the HAKKO FU-601 ensures effective soldering at low temperatures.

2. Cleaning

Always clean the soldering tip before use, to remove any residual solder or flux adhering to it by using a tip cleaner. Contaminants on the tip have many deleterious effects, including reduced heat conductivity, which contribute to poor soldering performance.

3. After use

Always clean the tip and coat it with fresh solder after use.
This guards against oxidation.

4. When the unit is not being used

Never allow the unit to idle at a high temperature for extended periods. This will allow the tip to become oxidized. Turn the power switch OFF. If it is to be out of service for several hours, it is advisable to disconnect the power plug as well.

5. Inspecting and cleaning the tip

This procedure, if followed daily, will materially add to tip life.

- a. Set the temperature to 250°C (482°F).
- b. When the temperature stabilizes, clean the tip and check the condition of the tip.
If the tip is badly worn or deformed, replace it.
- c. If the solder plated part of the tip is covered with black oxide, apply fresh solder, containing flux, and clean the tip again. Repeat until all the oxide is removed, then coat the tip with fresh solder.
- d. Turn the power OFF and remove the tip, using the heat resist pad. Set the tip aside to cool.
Remaining oxides can be removed with isopropyl alcohol.

⚠ CAUTION

NEVER file or use abrasive materials on the tip to remove oxides!

● The HAKKO FU-6001 maintenance

After the HAKKO FU-6001 is used for soldering, the unit (particularly the flux protector) is heavily deposited with flux.

If you insert a tip into the unit with flux deposit in or around the hole of the flux protector, the flux may be entrained into the hole and deposit on the terminal of the HAKKO FU-6001, causing poor contact (sensor error).

Regularly wipe off the flux using alcohol.

If wiping the flux protector did not remove the flux or dirt or the flux protector was deformed, replace it.

⚠ CAUTION

NEVER use thinner or other solvent to wipe the unit and the flux protector. Doing so may melt the resin part.

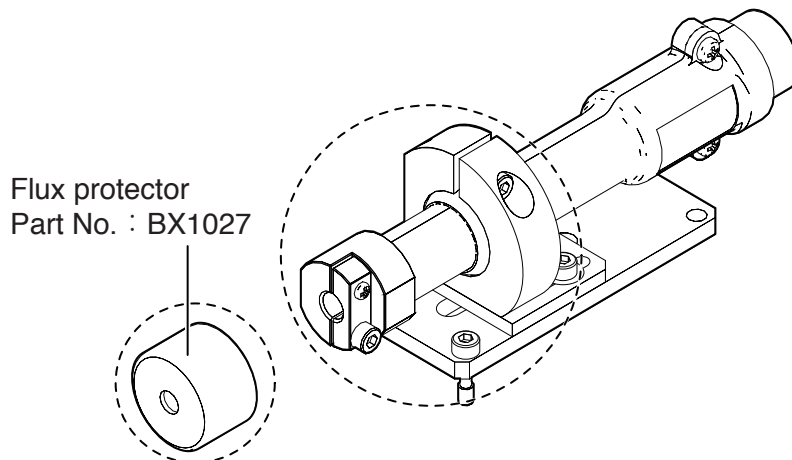

9. CHECKING PROCEDURE

WARNING

Unless otherwise directed, carry out these procedures with power switch OFF and the power UNPLUGGED.

■ Check for a broken heater or sensor

Verify the electrical integrity of the heater and sensor.

Measure the resistance of the heater and sensor while at room temperature (15°C to 25°C; 59°F to 77°F). It should be $3.4\Omega \pm 10\%$. If the resistance exceeds these limits, replace it.

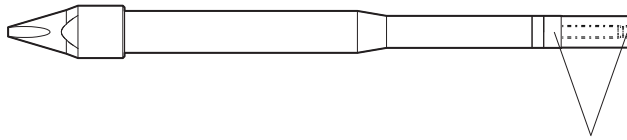

Measure the resistance across this position

■ Check the grounding line

1. Unplug the iron cable from the station.
2. Measure the resistance between the pin 2 and tip with the iron cable connected to the HAKKO FU-6001.
3. If the value exceeds 2Ω (at room temperature), perform the tip maintenance in page 15. If the value still does not decrease, check the connection cord for breakage.

■ Check the iron cable for breakage

Measure the resistance of the pin.

Pin 1 to Pin 3 - 3.0 to 3.8Ω

If the resistance exceeds these limits, replace the iron cable.

Contact your HAKKO representative.

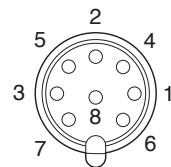

■ Replace the fuse

1. Unplug the power cord from the power receptacle.
2. Remove the fuse holder.
3. Replace the fuse.
4. Put the fuse holder back in place.

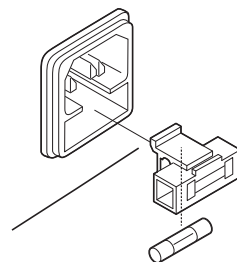

10. ERROR MESSAGES

CAUTION

If any of the errors occur, the Ready signal output to the HAKKO FU-500 will be “Not Ready”.

● Sensor error



When there is possibility that a failure has occurred in the sensor or heater (including the sensor circuit), **S-E** is displayed and a buzzer sounds.

● Soldering iron error



I-E is displayed and a buzzer sounds if the iron cable is not attached to the station or wrong soldering iron is connected.

● Low-temperature alarm tolerance error



If the tip temperature falls below the low-temperature alarm limit, **H-E** is displayed and a buzzer sounds. When the tip temperature rises above the low-temperature alarm limit, a buzzer will stop.

Example : 350°C (400°C – 50°C)

Set temperature |
Low-temperature alarm tolerance

● Heater terminal short circuit error



HSE is displayed and a buzzer sounds when the tip inserted incorrectly, an incompatible tip is inserted, or a foreign object has found its way into the connector.

● Abnormally high temperature error



When the tip temperature exceeds the temperature setting plus 50°C and this high temperature state lasts for 10 seconds or longer, the soldering iron is immediately de-energized and **AHE** is displayed and a buzzer sounds.

Note that the system will not recover from the error status even if the high temperature state is corrected. (The error status can be canceled only by turning the power off.)

● System error



When a system error occurs such as data flash, the soldering iron is immediately de-energized and **---** is displayed.

11. TROUBLE SHOOTING GUIDE

●The unit does not operate when the power switch is turned ON.

CHECK : Is the power cord and/or the connection plug disconnected?

ACTION : Connect it.

CHECK : Is the fuse down?

ACTION : Investigate why the fuse blew and then replace the fuse.
If the fuse blows again, send the unit in for repair.

●The tip does not heat up.

• The sensor error $\boxed{5-9}$ is displayed.

CHECK : Is the tip inserted properly?

ACTION : Insert the tip completely.

CHECK : Is the iron cable and/or the heater/sensor for breakage?

ACTION : See “■ Checking the iron cable for breakage” and “■ Check for a broken heater or sensor” in page 17. Replace any faulty part.

●Solder does not wet the tip.

CHECK : Is the tip temperature too high?

ACTION : Set the appropriate temperature.

CHECK : Is the tip contaminated with oxide?

ACTION : Remove the oxide.

(See “● Tip maintenance” in page 15.)

●The tip temperature is too high

CHECK : Is the iron cable broken?

ACTION : See “■ Checking the iron cable for breakage” in page 17.

CHECK : Is the entered offset value correct?

ACTION : Enter the correct value.

●The tip temperature is too low.

CHECK : Is the tip contaminated with oxide?

ACTION : Remove the oxide.

(See “● Tip maintenance” in page 15.)

CHECK : Is the entered offset value correct?

ACTION : Enter the correct value.

●The soldering iron error $\boxed{7-9}$ is displayed.

CHECK : Is the other soldering iron connected? Or the iron cable is connected?

ACTION : Connect the iron cable with the HAKKO FU-6001.

● **The low-temperature alarm tolerance error H-E is displayed.**

CHECK : Is the tip too small for the items to be soldered?

ACTION : Use a tip with a larger thermal capacity.

CHECK : Is the setting value for the low-temperature alarm tolerance too low?

ACTION : Increase the setting value.

● **Heater terminal short circuit error HSE is displayed.**

CHECK : Is the tip for the HAKKO FU-6001?

ACTION : Turn the power switch OFF and insert the genuine HAKKO FU-6001 tip. Turn the power switch ON.

● **Abnormally high temperature error AHE is displayed.**

ACTION : Contact your HAKKO representative.

● **System error --- is displayed.**

ACTION : Contact your HAKKO representative.

※ 各言語（日本語、英語、中国語、フランス語、ドイツ語、韓国語）の取扱説明書は以下のURL、HAKKO Document Portalからダウンロードしてご覧いただけます。
（商品によっては設定の無い言語がありますが、ご了承ください）

* 各國語言(日語,英語,中文,法語,德語,韓語)的使用說明書可以通過以下網站的HAKKO Document Portal 下載參閱。
(有一部分的產品沒有設定外語對應,請見諒)

* Instruction manual for the language, Japanese, English, Chinese, French, German and Korean can be downloaded from the following URL, HAKKO Document Portal.
(Please note that some language may not be available depending on the product.)

➡ <https://doc.hakko.com>

12. DIMENSIONAL OUTLINE DRAWING

HAKKO FU-6001
connected to the feeder unit

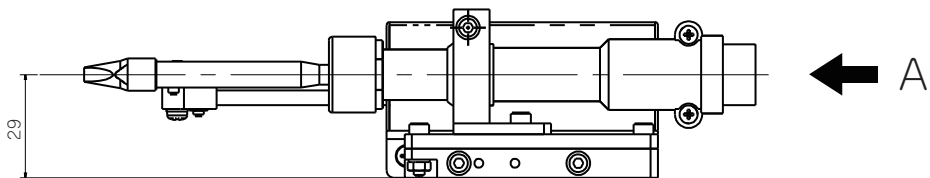
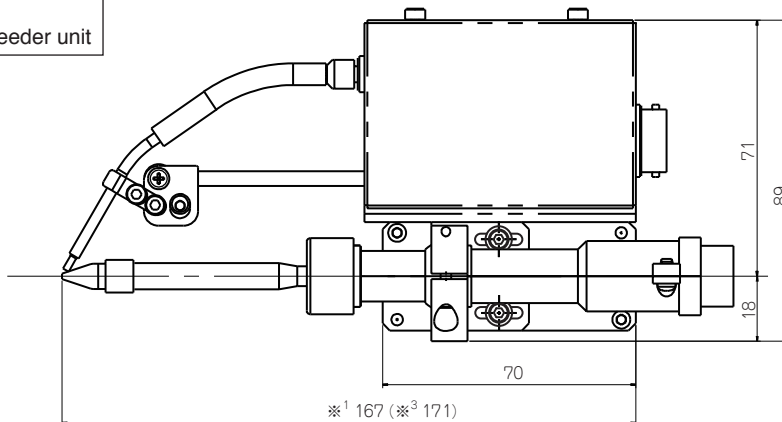

Back view of A

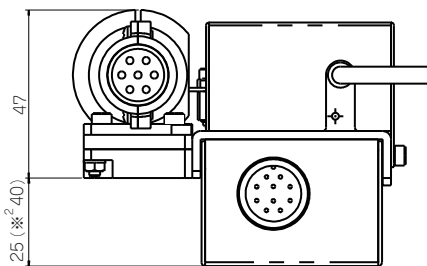

※² Connected to the feeder unit for $\phi 1.2-1.6\text{mm}$

HAKKO FU-6001
disconnected

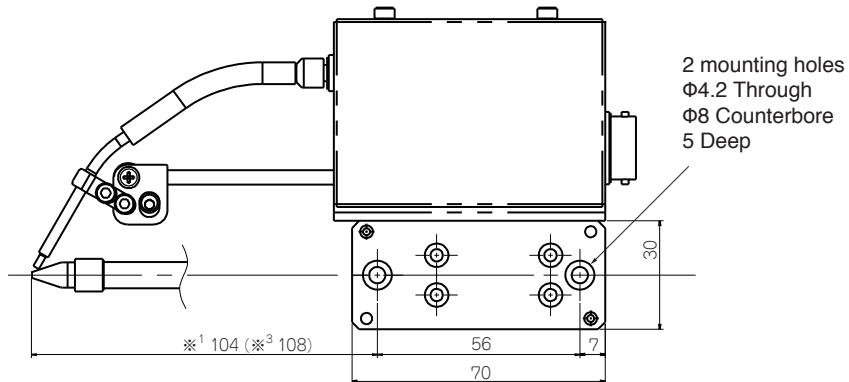

※¹ The dimension can be adjusted in range of $\pm 5\text{mm}$.
 ※³ When the tip using a long.

13. EXPLODED VIEW

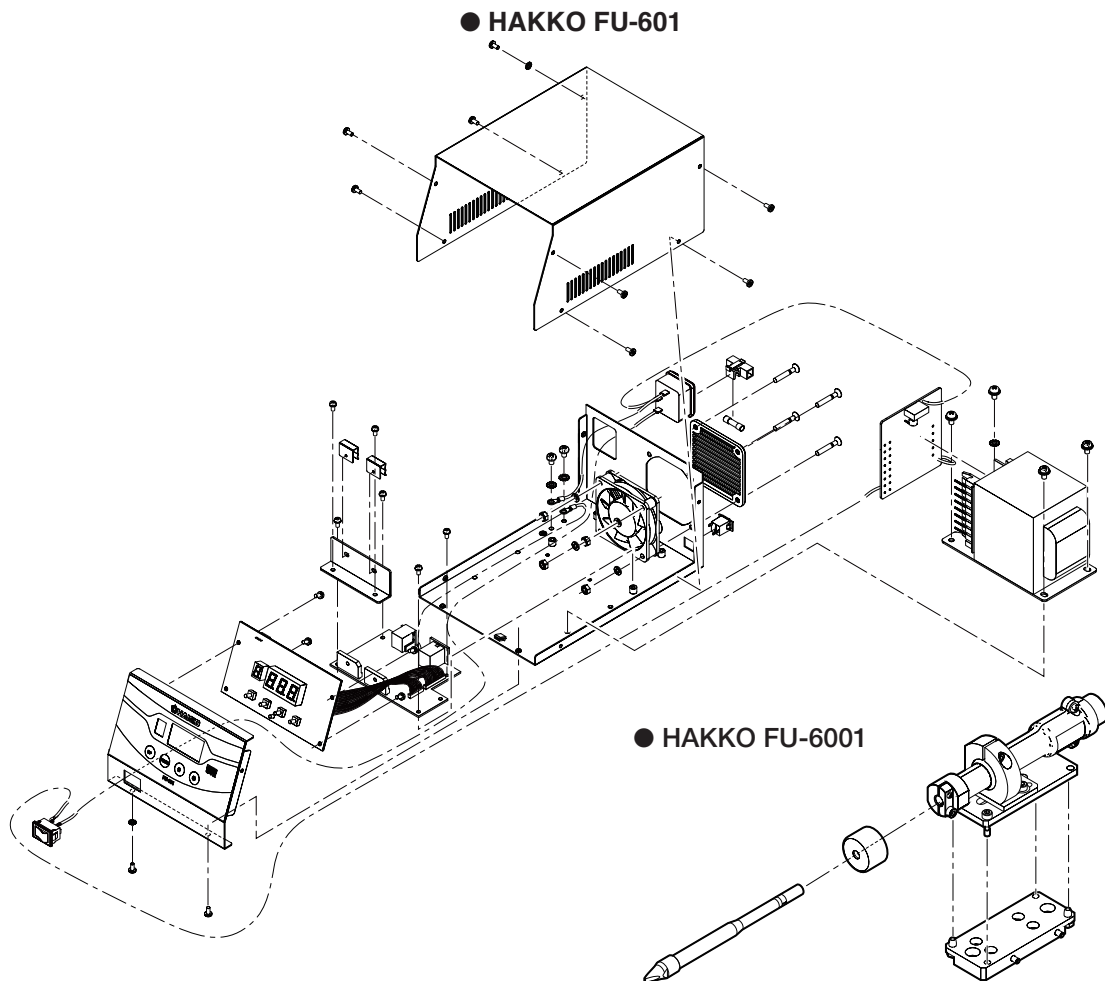

14. PARTS LIST

For more information about replacement parts or latest information, please visit our website (<http://www.hakko.com>) or HAKKO Document Portal. (see below)

Item No.	Part No.	Part Name	Specifications
①	FU6001-01X	HAKKO FU-6001	with Flux protector
②	FU6002-01X	HAKKO FU-6002	with Flux protector
③	BX1027	Flux protector	
④	BX1032	Iron cable	3 m

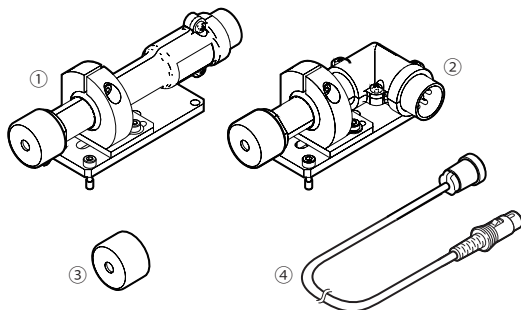

● Optional parts

Part No.	Part Name	Specifications
BX1033	Iron cable	5 m
BX1034	Iron cable	8 m

TIP STYLES

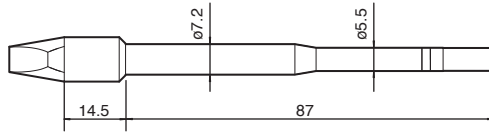

Unit : mm

TX2-XD3 Shape-3XD

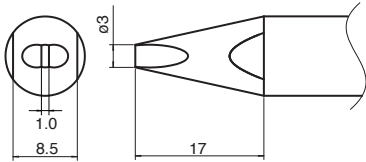

TX2-XD4 Shape-4XD

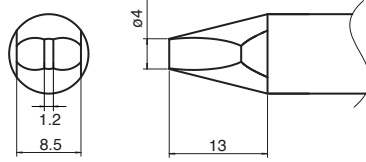

TX2-XD6 Shape-6XD

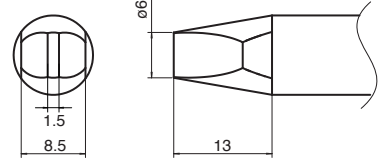

TX2-XBCR3 Shape-3XBCR

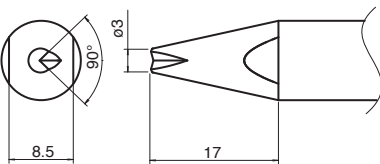

TX2-XBCR4 Shape-4XBCR

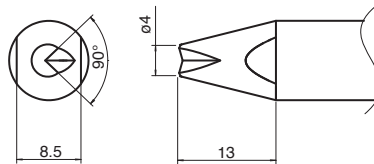

TX2-XBCR6 Shape-6XBCR

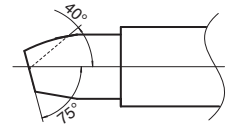
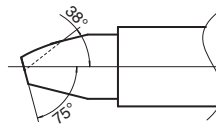
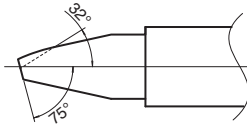
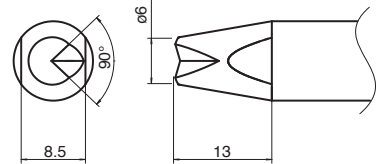

TX2-XDR3 Shape-3XDR

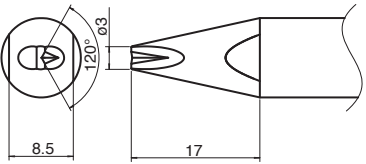

TX2-XDR4 Shape-4XDR

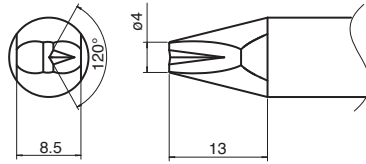

TX2-XDR6 Shape-6XDR

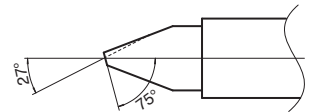
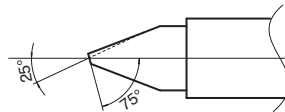
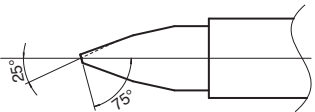
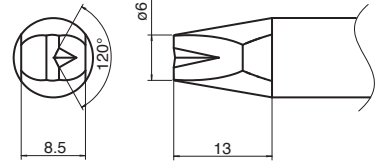

HAKKO CORPORATION
HEAD OFFICE

4-5, Shiokusa 2-chome, Naniwa-ku, Osaka 556-0024 JAPAN
TEL:+81-6-6561-3225 FAX:+81-6-6561-8466
<http://www.hakko.com> E-mail:sales@hakko.com

OVERSEAS AFFILIATES

U.S.A.: AMERICAN HAKKO PRODUCTS, INC.
TEL: (661) 294-0090 FAX: (661) 294-0096

Toll Free (800)88-HAKKO
4 2 5 5 8
<http://www.hakkousa.com>

HONG KONG: HAKKO DEVELOPMENT CO., LTD.
TEL: 2811-5588 FAX: 2590-0217
<http://www.hakko.com.hk>

E-mail:info@hakko.com.hk

SINGAPORE: HAKKO PRODUCTS PTE., LTD.
TEL: 6748-2277 FAX: 6744-0033
<http://www.hakko.com.sg>

E-mail:sales@hakko.com.sg

Please access to the following address for the other Sales affiliates.

<http://www.hakko.com>

Copyright © 2015 HAKKO Corporation. All Rights Reserved.

2015.4
MA02745XZ150413